

WIRE MANAGEMENT

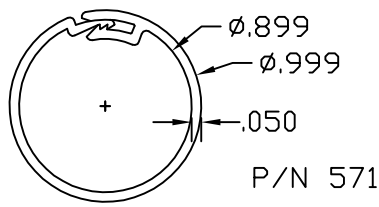

CLOSED

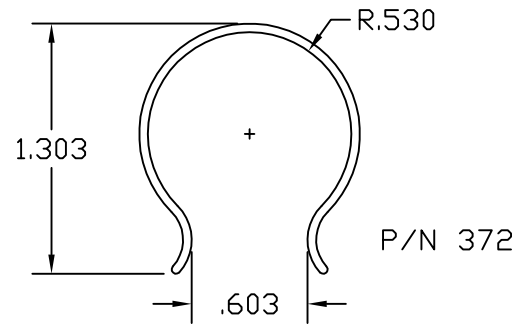
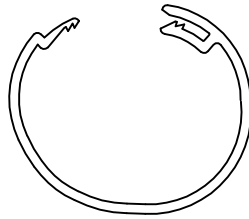

P/N 372

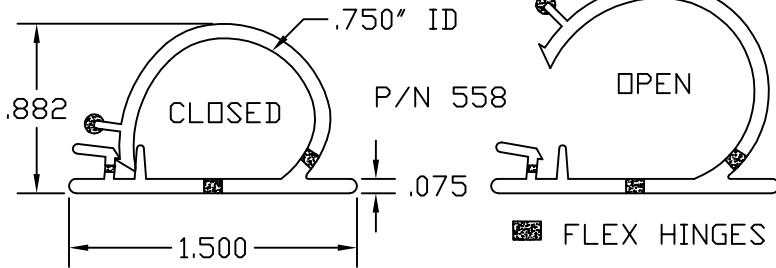

CLOSED

OPEN

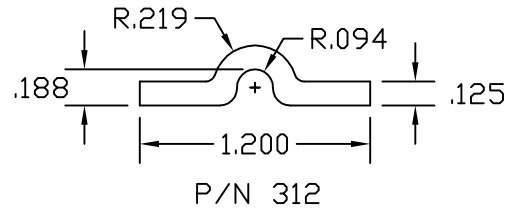

P/N 312

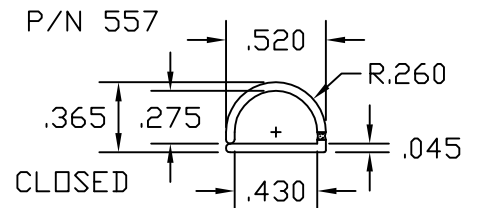
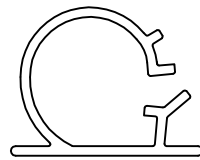
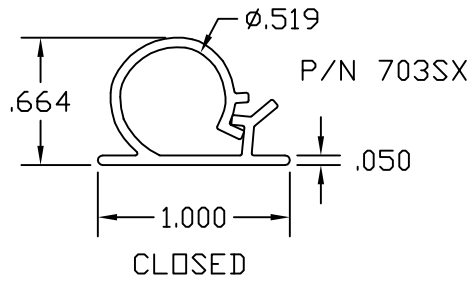

OPEN

FLEX HINGE

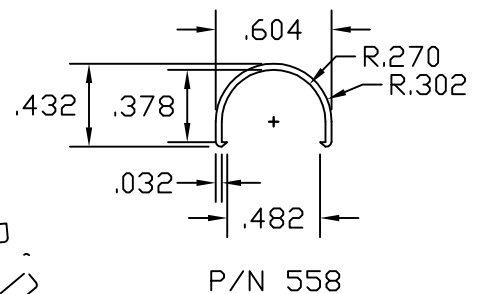
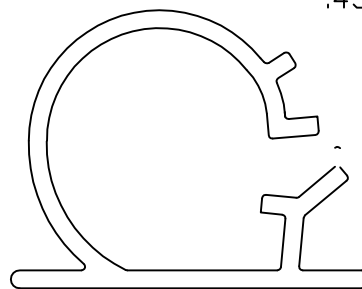
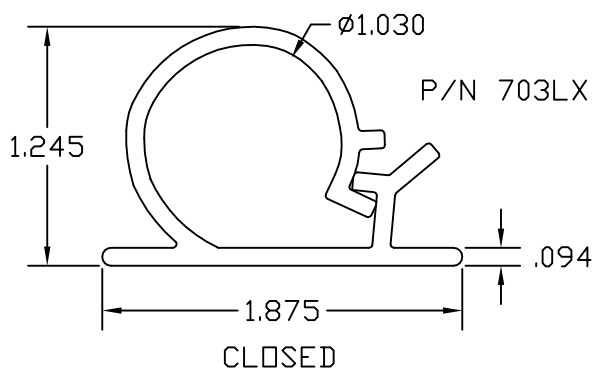
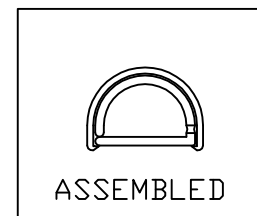
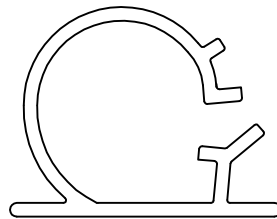
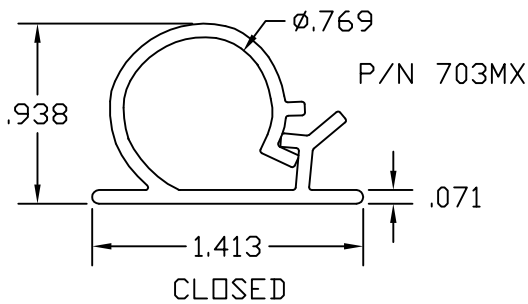

P/N 558

